



COMMERCIAL QUALITY

ROUTER BITS & CUTTERS

2023 CATALOGUE

www.capitalcutters.co.nz

BOTTOM CLEANING

2 FLUTES

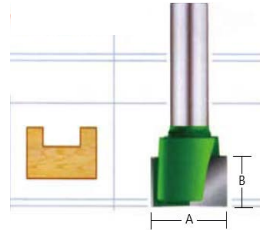

PART No.	A	B	SHANK
1120	3/4" (19.05mm)	9/16" (14.3mm)	1/4"
1123	1 - 1/2" (38.1mm)	3/4" (19.05mm)	1/2"
1121	3/4" (19.05mm)	9/16" (14.3mm)	1/2"
1122	1" (25.4mm)	5/8" (15.9mm)	1/2"

1

V-GROOVE - 90°

2 FLUTES

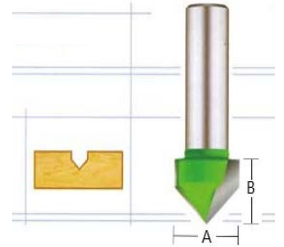

PART No.	A	B	SHANK
1140	1/8" (3.8mm)	1/2" (12.7mm)	1/4"
1141	1/2" (12.7mm)	1/2" (12.7mm)	1/4"
1142	3/4" (19.05mm)	5/8" (15.9mm)	1/4"
1143	1" (25.4mm)	3/4" (19.05mm)	1/4"

PART No.	A	B	SHANK
1145	3/4" (19.05mm)	5/8" (15.9mm)	1/2"
1146	1" (25.4mm)	3/4" (19.05mm)	1/2"
1147	1-1/2" (38.1mm)	1-1/4" (31.75mm)	1/2"

4

DISH CUTTER

PART No.	A	B	R	SHANK
1124	1" (25.4mm)	1/2" (12.7mm)	3/16" (4.7mm)	1/4"
1125	1-1/4" (31.75mm)	1/2" (12.7mm)	3/16" (4.7mm)	1/2"

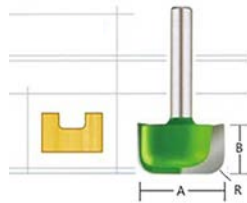

2

DOUBLE FLUTED STRAIGHT

PART No.	A	D	SHANK
1150	3/4" (19.05mm)	1/4" (6.35mm)	1/4"
1151	3/4" (19.05mm)	5/16" (7.95mm)	1/4"
1152	3/4" (19.05mm)	3/8" (9.5mm)	1/4"
1153	3/4" (19.05mm)	1/2" (12.7mm)	1/4"
1154	3/4" (19.05mm)	5/8" (15.9mm)	1/4"
1155	3/4" (19.05mm)	3/4" (19.05mm)	1/4"
1156	3/4" (19.05mm)	1" (25.4mm)	1/4"

PART No.	A	D	SHANK
1160	3/4" (19.05mm)	1/4" (6.35mm)	1/2"
1161	3/4" (19.05mm)	5/16" (7.95mm)	1/2"
1163	3/4" (19.05mm)	3/8" (9.5mm)	1/2"
1164	1" (25.4mm)	7/16" (11.11mm)	1/2"
1165	1-3/16" (30.16mm)	1/2" (12.7mm)	1/2"
1167	2" (50.8mm)	1/2" (12.7mm)	1/2"
1168	1-3/16" (30.16mm)	5/8" (15.9mm)	1/2"
1169	2-1/2" (63.5mm)	5/8" (15.9mm)	1/2"
1170	1-3/16" (30.16mm)	11/16" (17.46mm)	1/2"
1171	1-3/16" (30.16mm)	3/4" (19.05mm)	1/2"
1172	2" (50.8mm)	3/4" (19.05mm)	1/2"
1173	1-3/16" (30.16mm)	1" (25.4mm)	1/2"
1174	2" (50.8mm)	1-3/16" (30.16mm)	1/2"
1175	1-3/16" (30.16mm)	1-1/4" (31.75mm)	1/2"
1176	1-3/16" (30.16mm)	1-3/8" (34.9mm)	1/2"
1177	1-3/16" (30.16mm)	1-5/8" (41.27mm)	1/2"

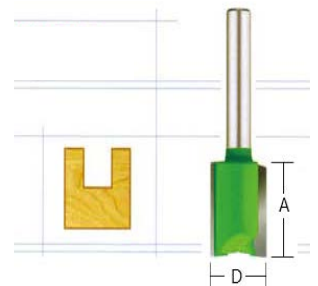

5

HINGE MORTISING

2 FLUTES

PART No.	A	B	SHANK
1126	1/2" (12.7mm)	3/4" (19.05mm)	1/4"
1127	5/8" (15.9mm)	3/4" (19.05mm)	1/4"
1128	3/4" (19.05mm)	3/4" (19.05mm)	1/4"
1126S	(12mm)	3/4" (19.05mm)	1/4"

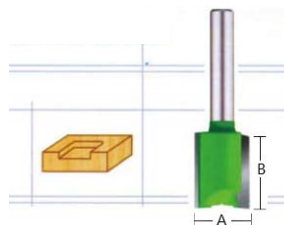

3

RABBETING/ SLOT CUTTING WITH BEARING

Clean End Face			
1179	(7mm)	(2.7mm)	1/4"
1187	15mm	3mm	
PART No.	A	B	SHANK
1180	3/8" (9.5mm)	1/16" (1.58mm)	1/4"
1181	3/8" (9.5mm)	1/8" (3.2mm)	1/4"
1182	3/8" (9.5mm)	5/32" (3.96mm)	1/4"
1183	3/8" (9.5mm)	3/16" (4.7mm)	1/4"
1184	3/8" (9.5mm)	1/4" (6.35mm)	1/4"
1185	3/8" (9.5mm)	3/8" (9.5mm)	1/4"
1186	3/8" (9.5mm)	1/2" (12.7mm)	1/4"
1188	1/4" (6.3mm)	1/2" (12.7mm)	1/4"
PART No.	A	B	SHANK
1190	3/8" (9.5mm)	1/8" (3.2mm)	1/2"
1191	3/8" (9.5mm)	1/4" (6.35mm)	1/2"
1193	3/8" (9.5mm)	3/8" (9.5mm)	1/2"
1194	3/8" (9.5mm)	1/2" (12.7mm)	1/2"
1195	3/8" (9.5mm)	5/8" (15.9mm)	1/2"
1196	1/4" (6.3mm)	1/2" (12.7mm)	1/2"
1197	1/2" (12.7mm)	1/2" (12.7mm)	1/2"
1198	5/8" (15.8mm)	1/2" (12.7mm)	1/2"

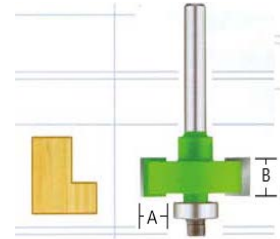

6

BULL NOSE

PART No.	D	B	SHANK
1200	1/4" (6.35mm)	1/2" (12.7mm)	1/4"
1201	3/8" (9.5mm)	1 - 1/16" (17.46mm)	1/4"
1202	1/2" (12.7mm)	1 - 3/16" (20.64mm)	1/4"
1203	5/8" (15.9mm)	1 - 3/16" (20.64mm)	1/4"
1204	3/4" (19.05mm)	1 - 1/16" (26.19mm)	1/4"
PART No.	D	B	SHANK
1210	1/4" (6.35mm)	1/2" (12.7mm)	1/2"
1211	3/8" (9.5mm)	5/8" (15.9mm)	1/2"
1212	1/2" (12.7mm)	13/16" (20.64mm)	1/2"
1213	5/8" (15.9mm)	13/16" (20.64mm)	1/2"
1214	3/4" (19.05mm)	1 - 1/16" (26.19mm)	1/2"
1215	1" (25.4mm)	1 - 3/8" (34.9mm)	1/2"
1216	1 - 1/8" (28.57mm)	1 - 3/8" (34.9mm)	1/2"
1217	1 - 1/4" (31.75mm)	1 - 5/8" (41.27mm)	1/2"
1218	1 - 3/8" (34.9mm)	1 - 3/4" (44.45mm)	1/2"
1219	1 - 1/2" (38.1mm)	1 - 3/4" (44.45mm)	1/2"

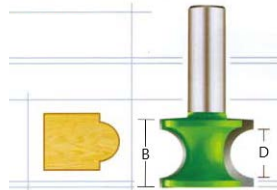

7

CORE BOX

PART No.	A	B	SHANK
1220	1/4" (6.35mm)	1/4" (6.35mm)	1/4"
1221	3/8" (9.5mm)	1/4" (6.35mm)	1/4"
1222	1/2" (12.7mm)	11/32" (8.73mm)	1/4"
1223	5/8" (15.9mm)	3/8" (9.5mm)	1/4"
1224	3/4" (19.05mm)	15/32" (11.9mm)	1/4"
PART No.	A	B	SHANK
1230	3/4" (19.05mm)	5/8" (15.9mm)	1/2"
1231	1" (25.4mm)	5/8" (15.9mm)	1/2"
1233	1 - 1/2" (38.1mm)	1" (25.4mm)	1/2"

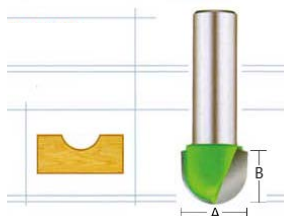

8

DOVETAIL

2 FLUTES

PART No.	DEG	A	B	SHANK
1240	7°	1/4" (6.35mm)	5/16" (7.95mm)	1/4"
1241	8°	5/16" (7.95mm)	1/4" (6.35mm)	1/4"
1242	14°	3/8" (9.5mm)	3/8" (9.5mm)	1/4"
1243	14°	1/2" (12.7mm)	1/2" (12.7mm)	1/4"
1244	14°	9/16" (14.28mm)	9/16" (14.28mm)	1/4"
1245	14°	3/4" (19.05mm)	3/4" (19.05mm)	1/4"
PART No.	DEG	A	B	SHANK
1250	14°	1/2" (12.7mm)	1/2" (12.7mm)	1/2"
1251	7°	5/8" (15.9mm)	3/4" (19.05mm)	1/2"
1252	7°	3/4" (19.05mm)	1 - 1/8" (28.5mm)	1/2"
1253	14°	3/4" (19.05mm)	5/8" (15.9mm)	1/2"
1254	14°	1" (25.4mm)	1 - 1/8" (28.5mm)	1/2"

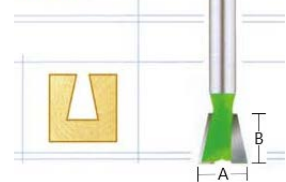

9

FLUSH TRIMMING

2 FLUTES

PART No.	A	B	SHANK
1265	22°	3/8" (9.5mm)	1/4"

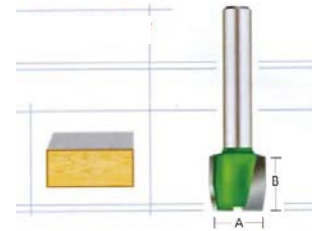

10

SLOT CUTTER

4 FLUTES, WITH BEARING

PART No.	A	B	C	SHANK
1270	1/8" (3.2mm)	2" (50.8mm)	9/16" (14.28mm)	1/4"
1271	5/32" (3.96mm)	2" (50.8mm)	9/16" (14.28mm)	1/4"
1272	3/16" (4.7mm)	2" (50.8mm)	9/16" (14.28mm)	1/4"
1273	1/4" (6.35mm)	2" (50.8mm)	9/16" (14.28mm)	1/4"
PART No.	A	B	C	SHANK
1275	1/8" (3.2mm)	2" (50.8mm)	9/16" (14.28mm)	1/2"
1276	5/32" (3.96mm)	2" (50.8mm)	9/16" (14.28mm)	1/2"
1277	3/16" (4.7mm)	2" (50.8mm)	9/16" (14.28mm)	1/2"
1278	1/4" (6.35mm)	2" (50.8mm)	9/16" (14.28mm)	1/2"
PART No.	A	B	C	SHANK
1280	1/8" (3.2mm)	1 - 7/8" (47.6mm)	1/2" (12.7mm)	1/4"
1281	3/16" (4.7mm)	1 - 7/8" (47.6mm)	1/2" (12.7mm)	1/4"
1282	1/4" (6.35mm)	1 - 7/8" (47.6mm)	1/2" (12.7mm)	1/4"
PART No.	A	B	C	SHANK
1285	1/8" (3.2mm)	1 - 7/8" (47.6mm)	1/2" (12.7mm)	1/2"
1286	3/16" (4.7mm)	1 - 7/8" (47.6mm)	1/2" (12.7mm)	1/2"
1288	1/4" (6.35mm)	1 - 7/8" (47.6mm)	1/2" (12.7mm)	1/2"

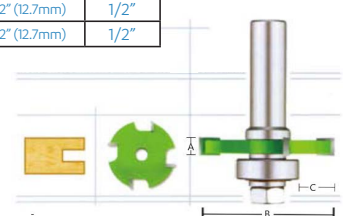

11

CHAMFER

WITH BEARING

PART No.	A	B	SHANK
1290	1" (25.4mm)	3/8" (9.5mm)	1/4"
1291	1-3/8" (34.9mm)	1/2" (12.7mm)	1/4"
PART No.	A	B	SHANK
1294	1-3/10" (9.5mm)	1/2" (12.7mm)	1/2"
1295	1-3/8" (34.9mm)	5/8" (15.9mm)	1/2"
1296	1-5/8" (41.27mm)	3/4" (19.05mm)	1/2"
1297	1-7/8" (47.62mm)	7/8" (22.22mm)	1/2"
1298	2-1/8" (53.9mm)	1-1/8" (28.57mm)	1/2"

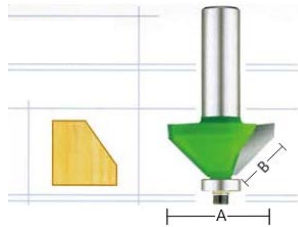

12

SHEAR CUT FLUSH TRIM

2 FLUTES, WITH BEARING

PART No.	A	B	SHANK
1315	1/2" (12.7mm)	1-3/16" (30.16mm)	1/4"
PART No.	A	B	SHANK
1317	1/2" (12.7mm)	1-3/16" (30.16mm)	1/2"

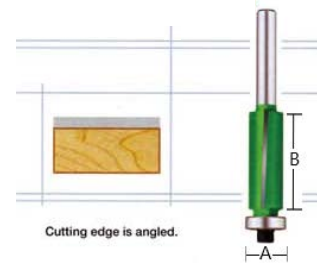

15

COVE

2 FLUTES, WITH BEARING

PART No.	A	B	SHANK
1300	1/16"R (1.58mm)	1/2" (12.7mm)	1/4"
1301	1/8"R (3.2mm)	1/2" (12.7mm)	1/4"
1302	3/16"R (4.7mm)	1/2" (12.7mm)	1/4"
1303	1/4"R (6.35mm)	1/2" (12.7mm)	1/4"
1304	5/16"R (7.95mm)	1/2" (12.7mm)	1/4"
1305	3/8"R (9.5mm)	5/8" (15.9mm)	1/4"
1306	1/2"R (12.7mm)	5/8" (15.9mm)	1/4"
PART No.	A	B	SHANK
1307	1/2"R (12.7mm)	5/8" (15.9mm)	1/2"
1308	3/4"R (19.05mm)	3/4" (19.05mm)	1/2"

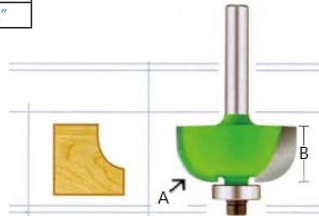

13

KEYHOLE

PART No.	A	B	C	SHANK
1318	1/2" (12.7mm)	1/4" (6.35mm)	1/4" (6.35mm)	1/4"
1319	3/8" (9.5mm)	3/16" (4.7mm)	1/4" (6.35mm)	1/4"

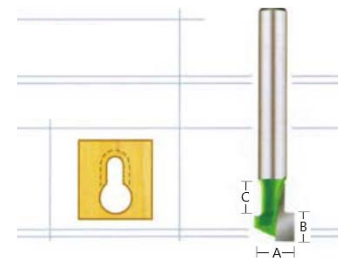

16

SHEAR CUT STRAIGHT

2 FLUTES

PART No.	A	B	SHANK
1310	1/4" (6.35mm)	3/4" (19.05mm)	1/4"
1311	1/2" (12.7mm)	3/4" (19.05mm)	1/4"
PART No.	A	B	SHANK
1313	1/2" (12.7mm)	1-3/16" (30.16mm)	1/2"

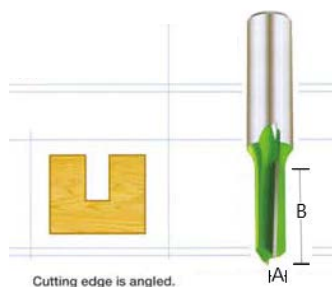

14

ROUNDROVER

WITH BEARING

PART No.	A	B	SHANK
1320	1/16"R (1.58mm)	1/2" (12.7mm)	1/4"
1321	1/8" (3.2mm)	1/2" (12.7mm)	1/4"
1321S	5/64 (2mm)	1/2" (12.7mm)	1/4"
1322	3/16"R (4.7mm)	1/2" (12.7mm)	1/4"
1323	1/4" (6.35mm)	1/2" (12.7mm)	1/4"
1324	5/16" (7.95mm)	1/2" (12.7mm)	1/4"
1325	3/8" (9.5mm)	5/8" (15.9mm)	1/4"
1326	1/2"R (12.7mm)	3/4" (19.05mm)	1/4"
PART No.	A	B	SHANK
1327	1/2"R (12.7mm)	3/4" (19.05mm)	1/2"
1328	5/8" (15.9mm)	1" (25.4mm)	1/2"
1329	3/4" (19.05mm)	1" (25.4mm)	1/2"
1330	7/8" (21.43mm)	1" (25.4mm)	1/2"
1331	1" (25.4mm)	1-1/2" (38.1mm)	1/2"
1332	1-1/4"R (31.75mm)	1-5/8" (41.27mm)	1/2"

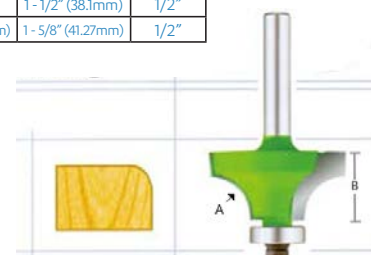

17

PLUNGING BALL

2 FLUTES

PART No.	A	B	SHANK
1334	1/2" (12.7mm)	1/2" (12.7mm)	1/4"
1335	3/4" (19.05mm)	3/4" (19.05mm)	1/4"
PART No.	A	B	SHANK
1336	1/2" (12.7mm)	1/2" (12.7mm)	1/2"
1337	3/4" (19.05mm)	3/4" (19.05mm)	1/2"
1338	1" (25.4mm)	1" (25.4mm)	1/2"
1339	1-1/4" (31.75mm)	1-1/4" (31.75mm)	1/2"

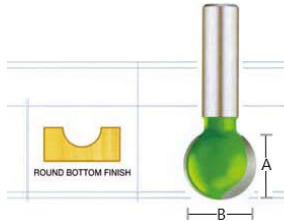

18

PANEL PILOT

PART No.	A	B	SHANK
1340	1/4" (6.35mm)	3/4" (19.05mm)	1/4"
PART No.	A	B	SHANK
1341	1/2" (12.7mm)	1-1/4" (31.75mm)	1/2"
1342	1/2" (12.7mm)	1-1/4" (31.75mm)	1/2"

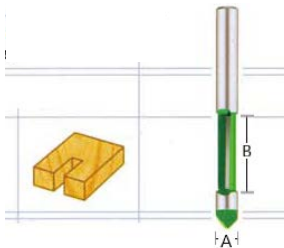

19

FLUSH TRIMMING

2 FLUTES, WITH BEARING

PART No.	A	B	SHANK
1344	1/4" (6.3mm)	1" (25.4mm)	1/4"
1345	3/8" (9.5mm)	1-3/16" (30.16mm)	1/4"
1346	1/2" (12.7mm)	1-3/16" (30.16mm)	1/4"
1347	5/8" (15.9mm)	1-3/16" (30.16mm)	1/4"
PART No.	A	B	SHANK
1348	1/2" (12.7mm)	1-3/16" (30.16mm)	1/2"
1349	5/8" (15.9mm)	1-1/8" (28.5mm)	1/2"

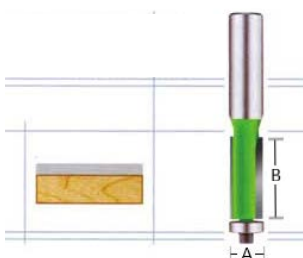

20

HINGE BORING

WITH CENTERING
POINTED TOE

PART No.	A	B	SHANK
1353	25mm	1/2" (12.7mm)	10mm
1354	30mm	1/2" (12.7mm)	10mm
1355	35mm	1/2" (12.7mm)	10mm
1356	40mm	1/2" (12.7mm)	10mm
1357	45mm	1/2" (12.7mm)	10mm

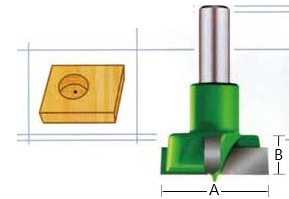

21

LAMINATE FLUSH TRIMMING

WITH BEARING

PART No.	A	B	SHANK
1359	22mm	5/8" (15.9mm)	1/4"

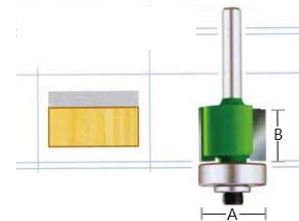

22

BEVEL TRIMMING

PART No.	A	B	SHANK
1366	5/8" (15.9mm)	3/8" (9.5mm)	1/4"

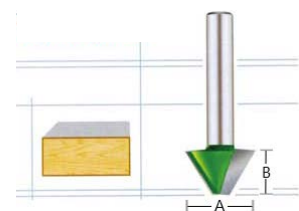

23

ROUNDNOSE

PART No.	R	A	B	SHANK
1375	1/8" (3.2mm)	1/4" (6.35mm)	3/8" (9.5mm)	1/4"
1376	3/16" (4.7mm)	3/8" (9.5mm)	1/2" (12.7mm)	1/4"
1377	1/4" (6.35mm)	1/2" (12.7mm)	1-5/8" (15.9mm)	1/4"
PART No.	R	A	B	SHANK
1378	5/16" (7.95mm)	5/8" (15.9mm)	5/8" (15.9mm)	1/2"
1379	3/8" (9.5mm)	3/4" (19.05mm)	3/4" (19.05mm)	1/2"
1380	1/2" (12.7mm)	1" (25.4mm)	1" (25.4mm)	1/2"

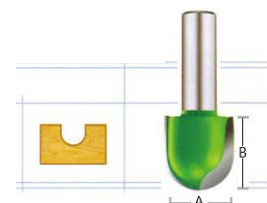

24

ROMAN OGEE WITH BEARING

PART No.	A	B	SHANK
1381	5/32"R (13.96mm)	1/2" (12.7mm)	1/4"
1382	1/4"R (6.35mm)	3/4" (19.05mm)	1/4"

PART No.	A	B	SHANK
1383	5/32"R (13.96mm)	1/2" (12.7mm)	1/2"
1384	1/4"R (6.35mm)	3/4" (19.05mm)	1/2"



25

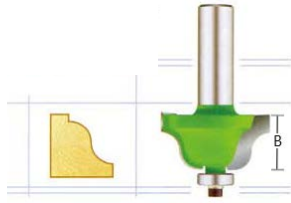

INTERNAL RADIUS

PART No.	A	B	SHANK
1385	3/8" (9.5mm)	7/8" (22.22mm)	1/4"
1386	1/2" (12.7mm)	7/8" (22.22mm)	1/4"
1387	3/4" (19.05mm)	1" (25.4mm)	1/4"

PART No.	A	B	SHANK
1388	3/8" (9.5mm)	7/8" (22.22mm)	1/2"
1389	1/2" (12.7mm)	7/8" (22.22mm)	1/2"
1390	3/4" (19.05mm)	7/8" (22.22mm)	1/2"
1391	1" (25.4mm)	1" (25.4mm)	1/2"
1392	1-1/4" (31.75mm)	1-1/8" (28.5mm)	1/2"



26

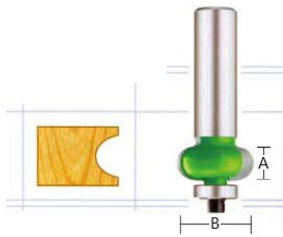

BEADING WITH BEARING

PART No.	A	B	SHANK
1393	1/16"R (1.58mm)	1/2" (12.7mm)	1/4"
1394	1/8" (3.2mm)	1/2" (12.7mm)	1/4"
1395	3/16"R (4.7mm)	1/2" (12.7mm)	1/4"
1396	1/4" (6.35mm)	1/2" (12.7mm)	1/4"
1397	5/16" (7.95mm)	1/2" (12.7mm)	1/4"
1398	3/8" (9.5mm)	5/8" (15.9mm)	1/4"
1399	1/2"R (12.7mm)	3/4" (19.05mm)	1/4"

PART No.	A	B	SHANK
1400	1/2"R (12.7mm)	3/4" (19.05mm)	1/2"
1401	3/4" (15.9mm)	1" (25.4mm)	1/2"



27

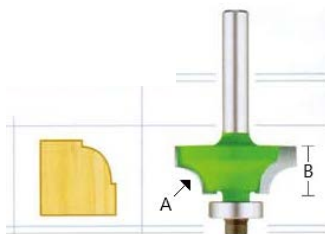

CLASSICAL PLUNGE

PART No.	A	B	SHANK
1403	1/2" (12.7mm)	3/16"R (4.7mm)	1/4"
1404	3/4" (19.05mm)	5/16"R (7.95mm)	1/4"
1405	1-1/16" (26.9mm)	15/16"R (23.8mm)	1/4"



28

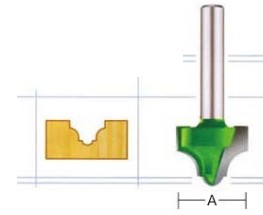

EDGE BEADING BIT I WITH BEARING

PART No.	A	B	SHANK
1406	1/4" (6.35mm)	7/8" (22.22mm)	1/4"

PART No.	A	B	SHANK
1407	1/8" (3.2mm)	3/4" (19.05mm)	1/2"
1408	1/4" (6.35mm)	7/8" (22.22mm)	1/2"
1409	3/8" (9.5mm)	7/8" (22.22mm)	1/2"



29

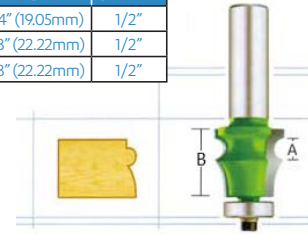

EDGE BEADING BIT III WITH BEARING

PART No.	A	B	SHANK
1410	3/16" (4.7mm)	3/4" (19.05mm)	1/4"
1411	5/16" (7.95mm)	13/16" (20.64mm)	1/4"



30

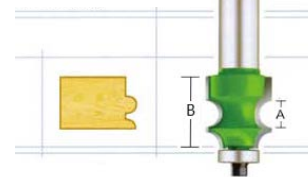

EDGE BEADING BIT II WITH BEARING

PART No.	A	B	SHANK
1412	5/16" (7.95mm)	7/8" (22.22mm)	1/4"

PART No.	A	B	SHANK
1413	1/2" (12.7mm)	1" (25.4mm)	1/2"



31

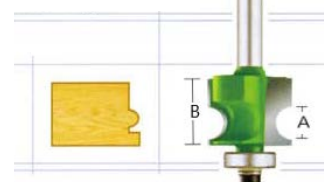

FLUTING

WITH UPPER & LOWER BEARINGS

PART No.	A	SHANK
1417	1/4" (6.35mm)	1/4"
PART No.	A	SHANK
1418	3/8" (9.5mm)	1/2"
1419	1/2" (12.7mm)	1/2"

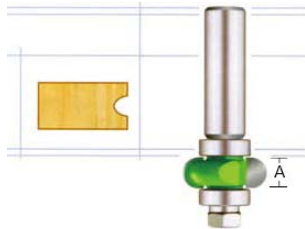

32

DOOR LIP

PART No.	B	SHANK
1420	1-5/8" (41.27mm)	1/2"
1421	1-5/16" (33.3mm)	1/2"
1422	1-7/8" (47.62mm)	1/2"

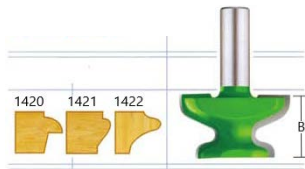

33

FINGER PULL

PART No.	A	B	C	SHANK
1423	1-3/8" (34.9mm)	3/4" (19.05mm)	5/8" (15.9mm)	1/2"
1424	1" (25.4mm)	3/4" (19.05mm)	1/2" (12.7mm)	1/2"

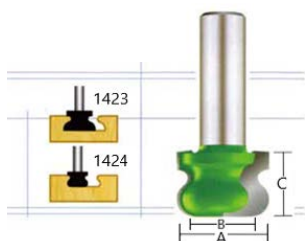

34

CLASSICAL WAVE

WITH BEARING

PART No.	A	B	SHANK
1425	2-1/4" (57.1mm)	3/4" (19.05mm)	1/2"

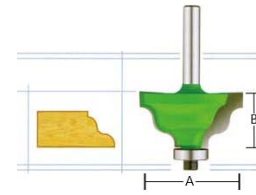

35

ROMAN OGEE/ROUND NOSE

WITH BEARING

PART No.	A	B	SHANK
1426	2" (50.8mm)	1" (25.4mm)	1/2"

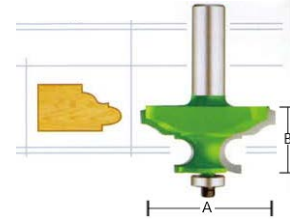

36

DOUBLE COVE & BEAD

WITH BEARING

PART No.	A	B	SHANK
1427	2" (50.8mm)	3/4" (19.05mm)	1/2"

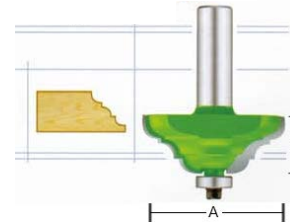

37

OGEE

WITH BEARING

PART No.	A	B	SHANK
1428	2" (50.8mm)	1" (25.4mm)	1/2"

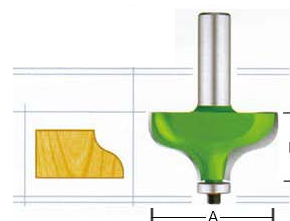

38

CLASSICAL PALACE

WITH BEARING



PART No.	A	B	SHANK
1430	1-1/8" (28.57mm)	3/4" (19.05mm)	1/2"
1431	1-3/8" (34.9mm)	1" (25.4mm)	1/2"
1432	1-5/8" (41.27mm)	1-5/16" (33.3mm)	1/2"

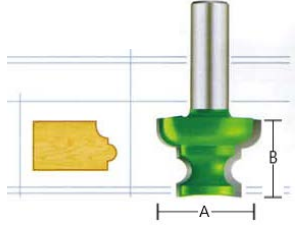

39

CLASSICAL WAVE

WITH BEARING



PART No.	A	B	C	SHANK
1441	3/8" (9.5mm)	1-1/4" (31.75mm)	9/16" (14.3mm)	1/4"
1442	7/16" (11.11mm)	1-3/8" (34.9mm)	5/8" (15.9mm)	1/4"
PART No.	A	B	C	SHANK
1443	3/8" (9.5mm)	1-1/4" (31.75mm)	9/16" (14.3mm)	1/2"
1444	9/16" (14.3mm)	1-5/8" (34.9mm)	3/4" (19.05mm)	1/2"

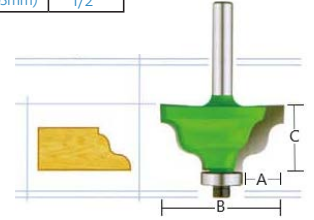

42

CLASSICAL COVE & BEAD

WITH BEARING



PART No.	A	B	C	SHANK
1433	3/8" (9.5mm)	1-1/4" (31.75mm)	5/8" (15.9mm)	1/4"
1434	1/2" (12.7mm)	1-1/2" (38.1mm)	3/4" (19.05mm)	1/4"
PART No.	A	B	C	SHANK
1435	3/8" (9.5mm)	1-1/4" (31.75mm)	5/8" (15.9mm)	1/2"
1436	1/2" (12.7mm)	1-1/2" (38.1mm)	3/4" (19.05mm)	1/2"

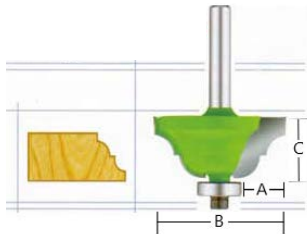

40

CLASSICAL BOLD

WITH BEARING



PART No.	A	B	SHANK
1447	1-1/2" (38.1mm)	1-1/8" (28.57mm)	1/2"

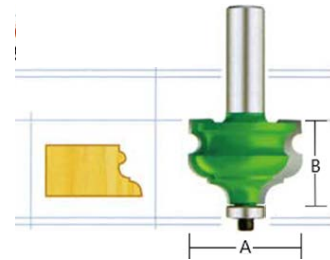

43

CLASSICAL OGEE

WITH BEARING



PART No.	A	B	C	SHANK
1437	5/16" (7.95mm)	1-1/8" (28.57mm)	1/2" (12.7mm)	1/4"
1438	7/16" (11.11mm)	1-3/8" (34.9mm)	1-1/16" (17.46mm)	1/4"
PART No.	A	B	C	SHANK
1439	5/16" (7.95mm)	1-1/8" (28.57mm)	1/2" (12.7mm)	1/2"
1440	7/16" (11.11mm)	1-3/8" (34.9mm)	1-1/16" (17.46mm)	1/2"

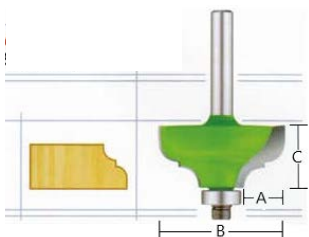

41

FACE MOULDING

WITH BEARING



PART No.	A	B	SHANK
1448	1-1/6" (26.9mm)	1-3/4" (44.45mm)	1/2"
1449	1-5/16" (7.95mm)	1-3/8" (34.9mm)	1/2"
1450	1-5/16" (7.95mm)	1-7/16" (36.5mm)	1/2"

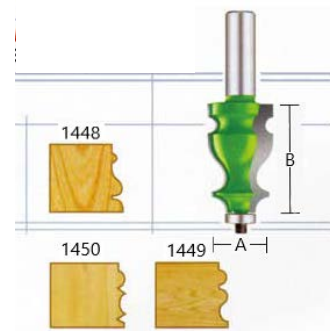

44

CAVE MOULDING

PART No.	A	B	SHANK
1451	1-1/4" (31.75mm)	1-3/4" (44.45mm)	1/2"

45

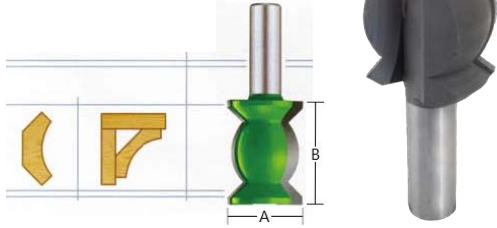

TONGUE & GROOVE ASSEMBLY

PART No.	A	B	SHANK
1460	1-7/16" (36.5mm)	1" (25.4mm)	1/2"

49

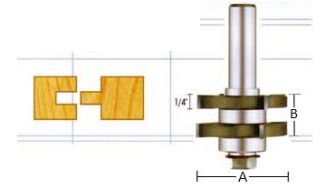

MULTIFORM BIT II WITH BEARING

PART No.	A	B	SHANK
1452	1-3/4" (44.45mm)	1-3/16" (30.16mm)	1/2"

46

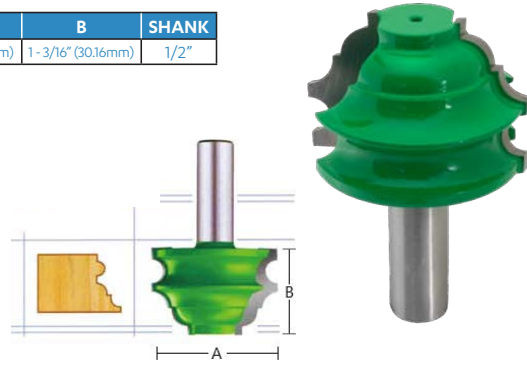

TONGUE & GROOVE V-MATCH SET WITH BEARING

PART No.	A	B	SHANK
1459	1-7/16" (36.5mm)	1" (25.4mm)	1/2"

50

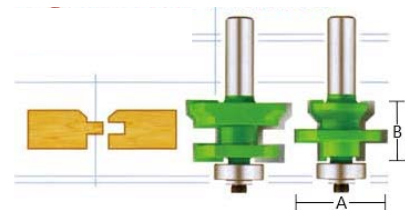

INSERTED SOLID CARBIDE STRAIGHT

2 FLUTES

PART No.	A	B	SHANK
1453	1/4" (6.35mm)	3/4" (19.05mm)	1/4"
1454	1/4" (6.35mm)	1" (25.4mm)	1/4"

47

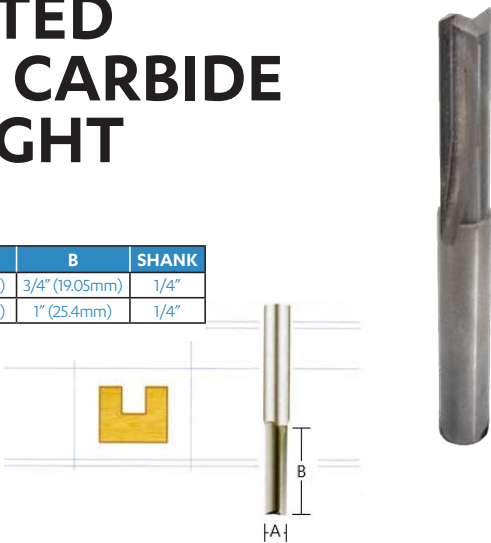

DRAWER LOCK

PART No.	A	B	SHANK
1461	1" (25.4mm)	1-1/2" (38.1mm)	1/2"

51

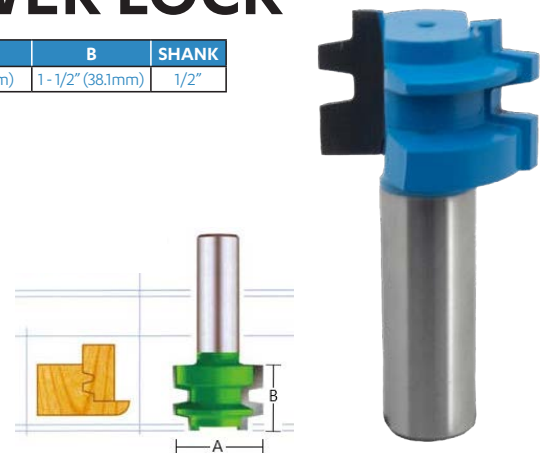

INSERTED SOLID CARBIDE STRAIGHT

1 FLUTE

PART No.	A	B	SHANK
1455	1/8" (3.2mm)	3/8" (9.5mm)	1/4"
1456	5/32" (3.95mm)	3/8" (9.5mm)	1/4"
1457	3/16" (4.7mm)	3/8" (9.5mm)	1/4"

48



CORNER LOCK MITER

PART No.	A	B	SHANK
1462	3" (76.2mm)	1" (25.4mm)	1/2"

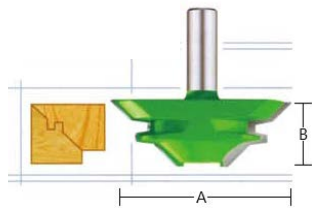

52

FLUTE & BEAD

PART No.	A	B	SHANK
1468	1-1/2" (38.1mm)	1/4" (6.35mm)	1/2"
1469	1-1/2" (38.1mm)	1/4" (6.35mm)	1/2"

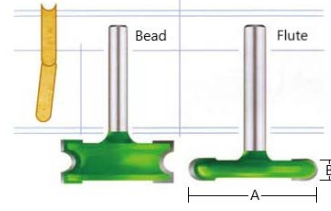

55

GLUE JOINT

PART No.	A	B	SHANK
1463	1-1/8" (28.57mm)	1-1/4" (31.75mm)	1/4"
PART No.	A	B	SHANK
1464	1-1/8" (28.57mm)	1-1/4" (31.75mm)	1/2"

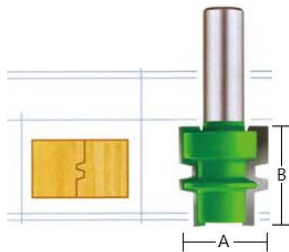

53

PATTERN

STRAIGHT PATTERN BITS - WITH UPPER BEARING

PART No.	A	B	SHANK
1470	1/2" (12.7mm)	3/4" (19.05mm)	1/4"
1470S	1/2" (12.7mm)	3/8" (9.5mm)	1/4"
1471	5/8" (15.9mm)	3/4" (19.05mm)	1/4"
1472	3/4" (19.05mm)	3/4" (19.05mm)	1/4"
1472S	3/4" (19.05mm)	3/8" (9.5mm)	1/4"
1503	1/2" (12.7mm)	1" (25.4mm)	1/4"
PART No.	A	B	SHANK
1473	3/4" (19.05mm)	1" (25.4mm)	1/2"
1474	3/4" (19.05mm)	2" (50.8mm)	1/2"
1475	1-1/8" (28.57mm)	1-3/16" (30.16mm)	1/2"

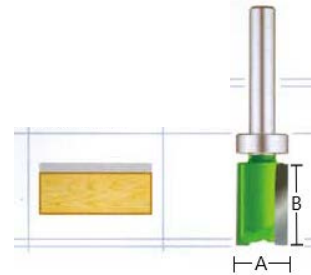

56

FINGER JOINT WITH BEARING

PART No.	A	B	SHANK
1467	1-5/8" (41.27mm)	1" (25.4mm)	1/2"

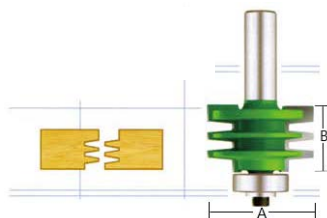

54

PATTERN BITS

STRAIGHT PATTERN BITS WITH UPPER BEARING

PART No.	A	B	SHANK
1501	1/2" (12.7mm)	1/2" (12.7mm)	1/4"
1502	3/4" (19.05mm)	1-1/2" (38.1mm)	1/2"

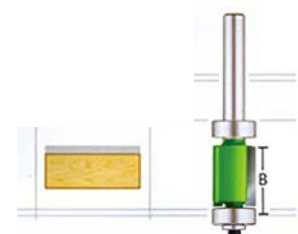

57

ROUTER BIT PRICELIST

(ALL PRICES EXCLUDE GST)

PART NO.	PRICE	PART NO.	PRICE	PART NO.	PRICE	PART NO.	PRICE	PART NO.	PRICE	PART NO.	PRICE
1102	\$53.79	1184	\$54.40	1272	\$86.02	1341	\$39.22	1401	\$75.39	1458	\$43.52
1103	\$58.74	1185	\$57.18	1273	\$86.02	1344	\$33.00	1403	\$48.96	1459	\$303.60
1105	\$63.75	1186	\$59.96	1275	\$84.00	1345	\$35.42	1404	\$55.53	1460	\$240.67
1112	\$53.79	1187	\$73.37	1276	\$84.00	1346	\$39.22	1405	\$74.26	1461	\$119.42
1113	\$58.74	1188	\$66.00	1277	\$86.02	1347	\$41.11	1406	\$87.12	1462	\$121.44
1115	\$63.75	1190	\$49.34	1278	\$86.02	1348	\$39.22	1407	\$87.12	1463	\$115.49
1117	\$70.51	1191	\$54.40	1280	\$84.00	1349	\$41.11	1408	\$87.12	1464	\$114.23
1119	\$82.89	1193	\$57.18	1281	\$84.00	1350	\$64.52	1409	\$87.12	1465	\$120.18
1120	\$55.55	1194	\$59.96	1282	\$86.02	1351	\$64.52	1410	\$87.49	1466	\$109.73
1121	\$55.55	1194S	\$61.60	1285	\$84.00	1352	\$64.52	1411	\$91.91	1467	\$233.09
1122	\$60.61	1195	\$62.93	1286	\$84.00	1353	\$60.97	1412	\$96.36	1468	\$81.84
1123	\$65.78	1196	\$66.00	1288	\$86.02	1354	\$58.44	1413	\$96.36	1469	\$81.84
1124	\$65.78	1197	\$72.60	1290	\$52.12	1355	\$78.81	1414	\$101.31	1470	\$43.51
1125	\$82.23	1198	\$77.00	1291	\$55.53	1356	\$88.55	1415	\$101.31	1470S	\$39.88
1126	\$28.59	1200	\$56.17	1294	\$55.53	1359	\$62.62	1416	\$158.50	1471	\$45.05
1126S	\$28.59	1201	\$63.76	1295	\$60.09	1360	\$66.16	1417	\$80.33	1472	\$48.95
1127	\$31.88	1202	\$63.76	1296	\$66.16	1361	\$66.16	1418	\$81.09	1472S	\$49.95
1128	\$35.86	1203	\$75.58	1297	\$75.58	1362	\$66.16	1419	\$85.01	1473	\$53.79
1132	\$53.76	1204	\$80.45	1298	\$80.33	1363	\$66.16	1420	\$109.74	1474	\$72.11
1133	\$56.04	1210	\$56.17	1300	\$52.12	1364	\$66.16	1421	\$109.74	1475	\$60.72
1138	\$50.73	1211	\$63.76	1301	\$53.13	1365	\$66.16	1422	\$109.74	1499	\$201.14
1140	\$38.90	1212	\$63.76	1302	\$55.53	1366	\$47.06	1423	\$89.18	1500	\$312.13
1141	\$42.00	1213	\$74.95	1303	\$56.93	1367	\$52.12	1424	\$109.74	1501	\$49.50
1142	\$54.40	1214	\$80.45	1304	\$58.82	1368	\$55.53	1425	\$117.01	1502	\$71.50
1143	\$65.15	1215	\$90.83	1305	\$60.72	1369	\$63.88	1426	\$122.98	1503	\$48.40
1145	\$54.40	1216	\$94.04	1306	\$62.62	1370	\$70.52	1427	\$122.98	RAC040	\$62.26
1146	\$65.15	1217	\$100.95	1307	\$62.62	1371	\$52.12	1428	\$122.98		
1147	\$91.08	1218	\$108.79	1308	\$72.36	1372	\$55.53	1429	\$118.28		
1150	\$23.91	1219	\$119.92	1310	\$30.36	1373	\$63.88	1430	\$82.10		
1151	\$23.91	1220	\$40.23	1311	\$30.36	1374	\$70.52	1431	\$90.83		
1152	\$23.91	1221	\$43.52	1313	\$30.87	1375	\$35.29	1432	\$98.29		
1153	\$23.91	1222	\$46.22	1315	\$45.29	1376	\$38.90	1433	\$90.83		
1154	\$23.91	1223	\$51.87	1317	\$45.29	1377	\$40.86	1434	\$98.29		
1155	\$30.68	1224	\$60.34	1318	\$42.00	1378	\$47.06	1435	\$90.83		
1156	\$33.40	1230	\$60.34	1319	\$42.00	1379	\$55.53	1436	\$98.29		
1160	\$23.91	1231	\$61.86	1320	\$50.73	1380	\$59.77	1437	\$90.83		
1161	\$23.91	1233	\$72.11	1321	\$50.73	1381	\$77.29	1438	\$98.29		
1163	\$23.91	1240	\$43.52	1321S	\$50.73	1382	\$80.33	1439	\$90.83		
1164	\$23.91	1241	\$45.54	1322	\$52.37	1383	\$77.29	1440	\$98.29		
1165	\$23.91	1242	\$46.81	1323	\$54.40	1384	\$80.33	1441	\$87.29		
1167	\$51.87	1243	\$51.23	1324	\$58.70	1385	\$48.83	1442	\$87.29		
1168	\$31.50	1244	\$54.40	1325	\$60.72	1386	\$50.60	1443	\$90.83		
1169	\$59.46	1245	\$58.19	1326	\$62.62	1387	\$64.01	1444	\$87.29		
1170	\$32.00	1250	\$51.23	1327	\$62.62	1388	\$48.96	1445	\$87.29		
1171	\$37.06	1251	\$58.19	1328	\$66.16	1389	\$49.21	1446	\$87.29		
1172	\$62.74	1252	\$64.52	1329	\$72.61	1390	\$64.01	1447	\$107.53		
1173	\$39.22	1253	\$58.19	1330	\$90.95	1391	\$77.04	1448	\$136.13		
1174	\$59.83	1254	\$64.52	1331	\$104.49	1392	\$95.82	1449	\$136.13		
1175	\$43.26	1260	\$49.34	1332	\$113.22	1393	\$50.73	1450	\$136.13		
1176	\$48.45	1261	\$53.13	1334	\$48.45	1394	\$50.73	1451	\$136.13		
1177	\$56.17	1262	\$56.93	1335	\$56.17	1395	\$52.37	1452	\$136.13		
1179	\$56.17	1263	\$61.99	1336	\$48.32	1396	\$52.37	1453	\$57.11		
1180	\$47.06	1264	\$65.78	1337	\$55.91	1397	\$58.70	1454	\$58.57		
1181	\$49.34	1265	\$44.28	1338	\$67.68	1398	\$58.70	1455	\$37.70		
1182	\$50.60	1270	\$84.00	1339	\$75.39	1399	\$61.86	1456	\$38.90		
1183	\$51.87	1271	\$84.00	1340	\$36.69	1400	\$61.86	1457	\$42.00		



Capital Cutters is run by boatbuilder Aaron Bilham, and is based in Lower Hutt, Wellington, servicing the whole of New Zealand.

Formerly owned by Brian and Vicky Eames under the company Western Marine Limited, Capital Cutters are New Zealand distributors for Sen Yeong Precision Tool Co., a Taiwanese manufacturer of high quality tungsten carbide router and shaper cutters. Solid carbide spiral and compression cutters for CNC tooling are also stocked.

022 3003 084

sales@capitalcutters.com

WWW.CAPITALCUTTERS.CO.NZ